

**SEA&SEA**

09132(BLACK)  
09133(WHITE)

**UNDERWATER LIGHTING SYSTEM**



***LX-2400SW FS***

Rev.1.00

English

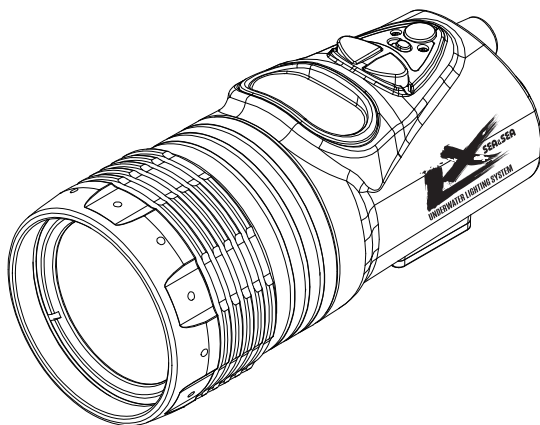

**Instruction Manual**

## Introduction

Thank you for purchasing SEA&SEA products.

Please read this instruction manual carefully prior to using your underwater strobe. Only with a thorough understanding of this manual's content will you be able to use the strobe correctly. After reading the manual, please be sure to keep it in a place where you can easily come back to it at any time.

### Note:

This products have passed SEA&SEA's criteria-based inspection for pressure resistance.



This device complies with Part 15 of the FCC Rules. Operation is subject to the following two conditions: (1) this device may not cause harmful interference, (2) this device must accept any interference received, including interference that cause undesired operation.



The product conforms to WEEE standards. This symbol indicates separate collection of waste electrical and electronic equipment in the EU countries. Please do not throw the equipment into the domestic refuse. Please contact your local authorities for recycling program information.

The appearance of color evenness or weld lines on the external body of the product is normal and will not affect its performance.

# CONTENTS

Safety Precautions .....	E-03
Safety precaution for use of battery .....	E-05
Precautions on Handling the O-ring .....	E-08
Check the bundle .....	E-10
Name of parts .....	E-11
Battery Installation .....	E-12
Charging the battery .....	E-13
Removable charging .....	E-13
Direct charging.....	E-13
Grip/base installation.....	E-15
Operating.....	E-16
Turning on/Mode switch/Turning off.....	E-16
4-step light adjustment (25% increments).....	E-16
100-step light adjustment (1% increments).....	E-16
Power lock.....	E-16
Flash sensor mode.....	E-17
Blinking signal mode.....	E-17
SOS mode.....	E-18
Replacing the light head.....	E-19
Procedure to switch the program .....	E-19
Safety design.....	E-20
High temperature protection mode .....	E-20
Safety mode .....	E-20
Care and storage precautions.....	E-21
Specifications.....	E-22

# Safety Precautions

This product has been designed for underwater use only. Limit light emission out of water to check the setting only.

Failure to heed the precautions listed below could result in serious consequences. To prevent injury or damage to yourself and/or others, please observe the precautions as they contain highly important information related to personal and product safety.

**DANGER**

Situations that involve a high risk of severe injury or death.

**WARNING**

Situations that could result in severe injury or death.

**CAUTION**

Situations that could result in personal injury or property damage. It also could result in loss of product quality or reliability.

**DANGER**

- Never attempt to disassemble, process, modify (soldering etc.), heat or put the product into fire. It could cause fire, electrocution, luminescence or fuming. Unauthorized disassembling and/or modification could result in flooding, malfunction or damage, and void product warranty. Take the product to a SEA&SEA authorized service center for repair or inspection.

**WARNING**

- Use only batteries approved for use in this product. Using unapproved batteries could cause gas resulting in explosion.
- Remove batteries before storage or transport. If stored or transported with the battery installed, it could cause unexpected activation resulting in fire.
- Do not turn the case or light head towards human bodies when opening. Heat from the batteries may cause pressure buildup inside the battery compartment, and could result in case or light head explosion with unexpected force.
- Prevent water or foreign objects from entering the product. It could cause fire or electrocution. The product has been constructed to ensure waterproofing but if flooding or leakage is noticed, turn off immediately and discontinue use.
- Do not handle batteries with wet hands. It could cause electrocution.
- Do not use the product in areas where there is a possibility of flammable or explosive gas. It could cause fire or explosion.
- Do not turn on with the light surface directly adjacent to the floor or desk. It could cause heat generation or fire.
- Do not touch the the light surface after turning on light. It could cause burns.
- Do not use the light towards the driver of a vehicle. It could make driving incapable from dazzling and cause accidents.

- Keep out of reach of children. There is a risk of accidental ingestion by swallowing included or small parts by mistake. If swallowed, seek medical advice immediately.

## CAUTION

- Read this instruction manual and observe proper precautions before use.
- This product has been designed and manufactured for use at a water depth within 100m/330ft. Please note that diving to a depth in excess of 100m/330ft may cause water leakage or damage to the product.
- Should you notice smoke or an unusual noise or smell coming from the product, turn it off immediately and take it to a SEA&SEA authorized service center.
- Should you notice flooding or leakage, turn it off immediately and discontinue use.
- If the product is flooded, interior pressure may build up. Please be careful when opening as water may gush out or the light head may open explosively. It may cause injuries.
- Do not open or close the light head near an open flame.
- This product has been constructed with an airtight seal and may cause air pressure difference inside and outside if carried on an airplane in a sealed condition. Please remove the light head when packing for airplane travel.
- Do not open or close the product in a wet or sandy environment or in areas where the indoor and outside temperature difference is large. Water drops or flooding may cause malfunction.
- Keep away from strong magnetic fields as it may not operate normally.
- Follow instructions from airline or hospital staff. Electromagnetic waves emitted by the product may interfere with measuring instruments or medical equipment.
- Do not cover or wrap the product with a cloth when using. Built up heat may cause deformation of the product or fire.
- Do not use the light close to the subject's eyes (especially infants). It may cause visual impairment if the light is emitted close to the eyes. The light should be more than 1 meter (3 feet) from the subject especially if photographing infants.
- Do not touch the light head being used for a long time. The temperature may get considerably high and result in low temperature burns if touched for a long time.
- Avoid strong shocks/impacts from dropping, swinging, jumping into the sea from a boat while holding or throwing into the sea etc. It may cause unexpected injury, damage or malfunction.
- Make sure that the light has been securely mounted to other products to prevent fall or loss. Do not bend or apply force more than necessary. It may cause unexpected injury, damage or malfunction.

- Do not lift or carry the housing by holding this product or attached accessories. It may cause unexpected injury or malfunction resulting in fall or damage. Hold the housing itself or grip when carrying.
- Do not place heavy items or sit on the product. Heavy weight may deform the outer casing and damage internal parts resulting in fire, electrocution or malfunction. It may also cause waterproofing failure.
- Rinse the product with fresh water after underwater use in a waterproof condition. (Refer to [Maintenance and Storage] for details.)
- Never use chemicals, cosmetics or petroleum solvents such as paint thinner, or neutral washing detergent as they may cause deformation or damage to the product.
- Do not leave the product in area where the temperature may become high. Especially, never leave it inside a car or a car trunk under the hot sun or in summer. As plastic is partially used in the product, the heat may deform the casing and damage internal parts resulting in potential fire, electrocution or malfunction. If the product is left sealed tight in hot environments, heated air expanding inside the product may deform the casing or warp and ruin the watertightness or cause condensation.
- Do not store the product in wet or areas with high humidity. It may cause mold, rust, corrosion or malfunction.
- Do not store the product with naphthalene or camphor mothballs, or in locations such as a laboratory where chemicals are used. It may cause mold, rust, corrosion or malfunction.
- If you do not use the product for an extended period of time, perform a test flash to keep internal electronic parts from deterioration by installing batteries once a month. Operate all other switches as you would in normal imaging operation. Then turn the light off and remove the battery.
- SEA&SEA assumes no liability for compensation of captured images or expenses caused by loss even if you are unable to shoot due to product defects.
- SEA&SEA will not be responsible for the replacement or compensation for cameras, lenses or other accessories damaged due to misuse of the product.
- Refer to [Precautions on Handling the O-ring] about handling O-rings.
- SEA&SEA assumes no liability for compensation of errors or discrepancies in this manual.
- Please note that specifications and appearance are subject to change without notice.
- The silicon grease included in the product is inedible.

# Safety precaution for use of battery

## DANGER

- Never expose the battery to flame, fire or excessive heat.
- Never solder the battery directly.
- Never attempt to disassemble or modify. It is dangerous as it could cause heat generation, fire or splashing of strong alkaline liquid.
- Never short-circuit the terminals of a battery (+ and -) with metal objects (wire, necklace, hairpin etc). Do not transport or store with any metal objects. It could result in battery leakage, heat generation, fire or explosion.
- When recharging batteries, use the specifically designed charger following the designated charging instructions. Not doing so could cause battery leakage, heat generation or explosion.
- Move leaking batteries away from fire or open flames immediately. The leaked fluid and its vapor could result in fire or explosion.
- If leakage occurs and touches skin or clothing, flush the affected area repeatedly with plenty of water. It could cause skin damage. If it gets into eyes, rinse with clean water without rubbing and seek medical advice immediately as there is a risk of blindness.
- Never connect a battery directly to a plug outlet or a car cigarette lighter.

## WARNING

- Do not immerse the battery in water/seawater or wet the battery terminals. It could cause heat generation or rusting of internal mechanism.
- Do not remove or damage the battery case and exterior tube. It could cause battery leakage, heat generation or explosion.
- Stop charging the battery if charging is not completed within the specified charging time. It could cause battery leakage, heat generation or explosion.
- Should you notice battery leakage, discoloration, deformation or other unusual conditions, do not use. If you find anything abnormal, discontinue use immediately and take it to a SEA&SEA authorized service center.
- Keep this product and batteries out of reach of children.
- Do not use or leave the product in areas in direct sunlight, inside a car under hot sun or places with high temperature such as the front of a stove. It could cause battery leakage, heat generation, decreased performance or shorten the product lifespan.
- Do not use unapproved batteries. It could cause leakage, heat generation or explosion resulting in injury or burns.

 **CAUTION**

- Avoid strong shocks/impacts or throwing the battery.
- Always charge the rechargeable batteries before use if they have not been used for an extended period of time.
- Dirt on the battery terminals may prevent the product from clear contact resulting in the power being turned off or the battery not getting charged. Wipe with a dry cloth to clean the terminals before use.
- Do not leave the battery connected to the device for a long time after use, make sure the power switch is off after using. If not it may cause leakage.
- Used Li-ion batteries are a valuable resource. Please take them to rechargeable battery recyclers after taping the terminals to insulate the battery.



# Precautions on Handling the O-ring

The product is kept watertight by the O-ring. To keep the O-ring functioning properly, please observe the following. Improper handling of the O-ring could cause flooding.

## CAUTION

- SEA&SEA products use blue O-rings. These O-rings are impregnated with silicone oil through a special process. The lubricating effect of the O-ring lasts as long as the silicone oil is gradually seeping out from within.
- For maintenance of these blue O-rings, make sure to use genuine SEA&SEA silicone grease (O-RING GREASE for blue O-rings: blue lettering and blue cap). If you use silicone grease from other companies or SEA&SEA's own silicone grease that has black lettering, the grease you apply will be sucked into the blue O-rings due to their special characteristics, which will result in insufficient grease. If this happens even once, the O-ring will not revert to its normal state and must be replaced.
- If the grease is insufficient, the O-ring will not slide and it will become harder to open and close the waterproof parts. It could make opening and closing impossible or cause flooding so avoid using with insufficient grease.

## Are there any scratches or cracks in the O-ring?

Check the O-ring to make sure there are no scratches or cracks. If there are, replace with a new O-ring immediately. When handling the O-ring, do not use pointed metal objects as they could damage the O-ring.

## Be careful about dust, sand and hair

Check the O-ring to make sure that there is no dust, sand or hair on the O-ring, in the O-ring's grooves or on the O-ring's contact surfaces. If any of these things are attached, remove them completely. Using as is could cause flooding.

## Apply silicone grease

Silicone grease reduces friction of the O-ring. After checking the O-ring to make sure that there are no scratches, dust or debris, apply a light coating of silicone grease to the entire O-ring with your finger. Applying too much grease will make it easier for dust and debris to adhere to the O-ring resulting in flooding. When fitting, insert the O-ring straight without twisting.

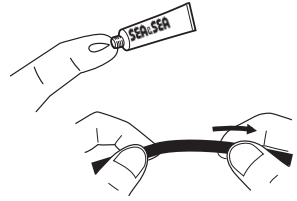

## Remove the O-ring for inspection before each use

In principle, the O-ring should be removed before each use so that the O-ring, O-ring groove and O-ring contact surfaces can be checked. This is because you cannot find any sand or dust that may have gotten into the O-ring groove if the O-ring is not removed. For routine maintenance prior to each use, we recommend removing the O-ring.

## Be careful about how you store O-rings

When storing spare O-rings or O-rings that you have removed, keep them in a cool place out of direct sunlight. Do not place heavy objects on the O-rings or bend them during storage.

## O-rings last for one year

Although it depends on the frequency of use and storage conditions etc., O-rings generally last for one year. It is advisable to inspect them before use and replace them early.

# Check the bundle

Before using the product, please make sure that all the bundled items are included.

**LX-2400SW FS**

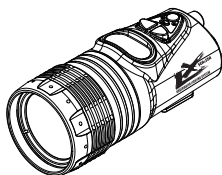

**Battery SB-L1**

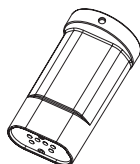

**Charger**

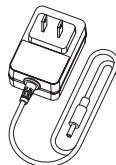

**Gun Grip**

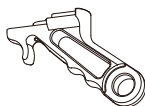

**Ball Base**



**YS Base**



**GoPro Base**



**Loc-Line Base**



**Charge Cap**



**Charge Plug**



**Wrist Lanyard**



**Fixing Screw**



**Allen Key**

5mm on the opposite side



**O-ring Grease**

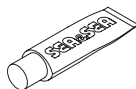

**O-ring Remover**

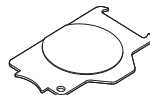

# Name of parts

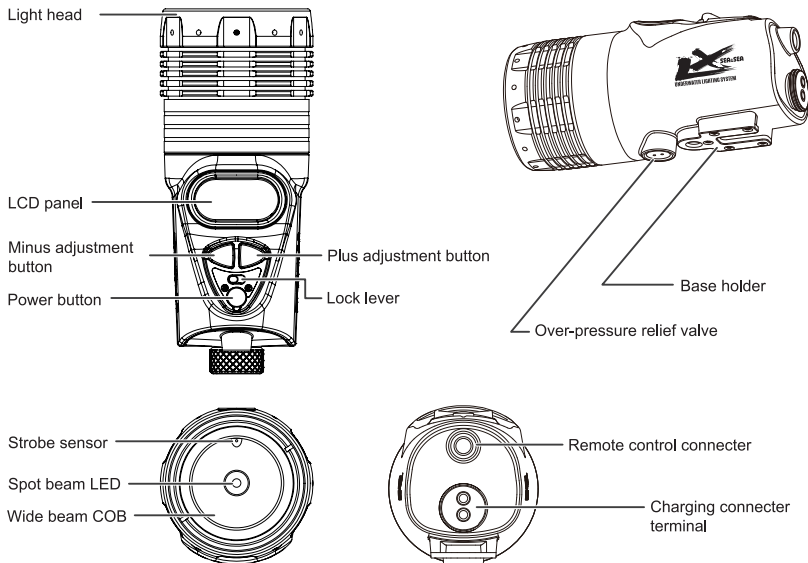

## LCD Display

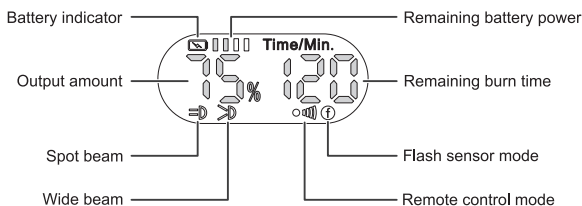

- Output amount : The current output amount is displayed in increments of 1%.
- Remaining battery power : The remaining battery power is displayed in 4 level bars.
- Remaining burn time : The remaining burn time is displayed in real time.

### **CAUTION**

- The remaining lighting time displayed in real-time is a theoretical value automatically calculated from remaining battery and amount of light. Please note that this value may differ from the actual remaining lighting time depending on the battery condition or circumstances such as surrounding water temperature.

# Battery Installation

- 1 Hold the body case firmly and rotate the light head counter-clockwise
- 2 Make sure there is no dirt or water on the metal terminals of the battery
- 3 Install the battery into the body case
- 4 Hold the body case firmly and set the light head by rotating clockwise
  - Twist the battery until the strobe light sensor comes to the top. Tightening more may make opening the light head difficult.

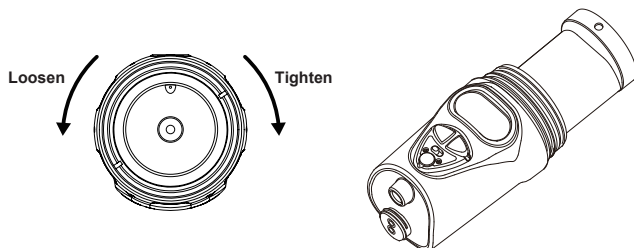

- Reverse the procedure to remove the battery

## **⚠ WARNING**

- Never work with wet hands or under wet circumstances due to the risk of electrocution or damage

## **⚠ CAUTION**

- Make sure no dust, sand etc. gets on the O-ring, O-ring groove or O-ring contact surface. Grease up the O-ring before closing the light head.
- Be careful not to drop when uninstalling the battery. It may cause not only damage to the battery but also injury to the user.

# Charging the battery

## Removable charging

- 1 Make sure that the light power is off
- 2 Remove the battery from the light
- 3 Insert the charger AC plug into a power outlet
  - Ensure the charger LED turns green
- 4 Insert the charger connector into the battery
  - Ensure the charger LED switches to red
- 5 Disconnect the connector from the battery when charging is complete
  - The charger LED switches to green once charging is complete. (2.5 hours max)

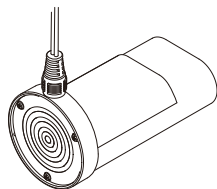

## Direct charging

As it is unnecessary to remove the light head, charging can be done with no risk of submersion in water.

- 1 Make sure that the light power is off
- 2 Insert the Charge Plug into the remote control connector of the light
- 3 Slide the Charge Plug counter-clockwise until it clicks
- 4 Insert the charger AC plug into a power outlet
  - Ensure the charger LED turns green
- 5 Insert the charger connector into the Charge Plug
  - Ensure the charger LED switches to red
- 6 Disconnect the connector and remove the Charge Plug from the light when charging is complete
  - The charger LED switches to green once charging is complete (2.5 hours max)

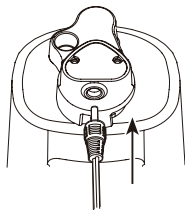
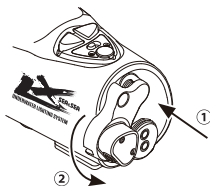

 **DANGER**

- Do not charge on paper, carpet or anything flammable as the battery and charger may become hot while charging.
- Do not charge with coiled cables as heat build-up may result in fire.
- Do not handle with wet hands or charge under wet circumstances to avoid electrocution.
- Do not charge any batteries that have been flooded, or are suspected of having water intrusion.

 **WARNING**

- Make sure there is no dirt or water on the charging connector terminals before charging. If there is any dirt or water, clean thoroughly. It may cause not only damage to the product but risk of electrocution.
- If it is charged with the light head facing down, ensure the light is not switched on.
- Remove the charging plug promptly once charging is complete. Leaving the charger connected to a power outlet may result in shortage of the adaptor and fire.
- Do not use underwater while the Charge Plug remains connected to the light. The charging plug is not waterproof.
- The charger is multi-volt compatible (100-240V), but use of unstable power supply such as a resort or on a cruise ship with in-house power generation may cause damage to the charger due to abnormally high voltage. We recommend combining a converter with a built-in safety circuit.

 **CAUTION**

- Charge in a stable position to avoid the plug being disconnected from the charging connector due to vibration, impact shock or dropping.
- Leaving the charging connector plugged in may cause over-discharge rendering the battery unable to take a subsequent charge.
- The charging connector terminal of the light is waterproof but if seawater remains after use, it may cause corrosion.
- The included Charge Cap protects and prevents water intrusion for the charging connector terminal. We strongly recommend attaching the Charge Cap while diving to protect the charging connector terminal from seawater.
- Do not leave the battery and charger in areas with high temperature or in direct sunlight.

# Grip/base installation

- 1 Insert the respective base by sliding into the base holder from the rear of the light
- 2 Secure the base lock screw by Allen Key

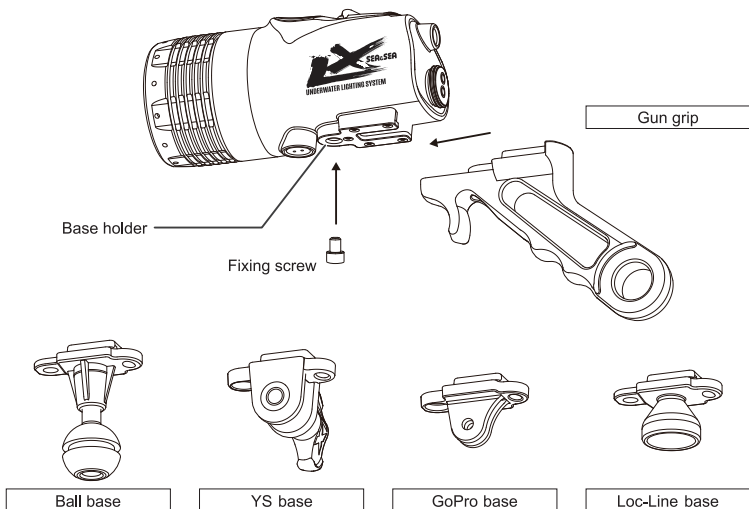

- A wrist lanyard can be affixed to the oval hole on each base



# Operating

## Turning on/Mode switch/Turning off

- 1 Press the power/light adjustment button to turn on
  - Mode and light intensity turn back on at the same condition from last use
- 2 Hold down the power/light adjustment button for about 1 second to switch the mode
- 3 Hold down the power/light adjustment button for about 3 seconds to turn off

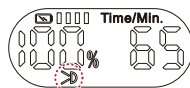

When wide light is on

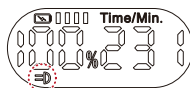

When spot light is on

Minus adjustment button



Plus adjustment button

Power button

Lock lever

- Mode switches for a moment just before turning itself off, but it is a specification, not an abnormality

## 4-step light adjustment (25% increments)

- 1 Light intensity circulates in 25% increments each time the power/light adjustment button is pressed
  - It circulates in order of [25%] > [50%] > [75%] > [100%] > [25%] ....

## 100-step light adjustment (1% increments)

- 1 Light intensity increases in 1% increments each time the light intensity adjustment button (+) is pressed
  - Holding down the button can fast forward to 100%
- 2 The light intensity decreases in 1% increments each time the light intensity adjustment button (-) is pressed
  - Holding down the button can fast forward to 0%

## Power lock

- 1 The power/light adjustment button gets locked by sliding the power lock lever to the right
  - It can prevent erroneous lighting while carrying or transportation

## Flash sensor mode

Light being captured from strobe imaging can be prevented, as the light turns off when sensing the strobe light

- 1 Press the power/light adjustment button to turn on
- 2 Hold down the light intensity adjustment buttons (+)(-) simultaneously for about 2 seconds to switch to the flash sensor mode
  - When it senses the strobe light emission, it automatically turns off and automatically turns back on in 1 second
  - The 'f' icon flashes on the LCD panel during the flash sensor mode
- 3 Hold down the light intensity adjustment buttons (+)(-) simultaneously for about 2 seconds again to switch back to the original mode

simultaneously for about 2 seconds

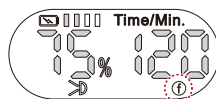

When in flash sensor mode

- Flash sensor may react to reflection of the light depending on the imaging circumstances. Please lower the light intensity in such cases.

## Blinking signal mode

You can tell your location to people around you or send signs to someone on the boat by repeating short blinks

- 1 Press the power/light adjustment button to turn on
- 2 Hold down the light intensity adjustment button (+) and the power/light adjustment button simultaneously for about 2 seconds again to switch back to original mode
  - The light repeats short blinks
- 3 Hold down the light intensity adjustment button (+) and the power/light adjustment button simultaneously for about 2 seconds again to switch back to original mode

simultaneously for about 2 seconds

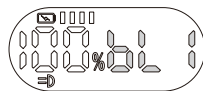
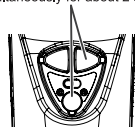

When in blinking signal mode

## SOS mode

You can send SOS signals for rescue.  
Never use except in emergencies.

- 1 Press the power/light adjustment button to turn on
- 2 Hold down the light intensity adjustment button (-) and the power/light adjustment button simultaneously for about 2 seconds to switch to SOS mode
  - It repeats [3 short blinks] > [3 long blinks] > [3 short blinks]
- 3 Hold down the light intensity adjustment button (-) and the power/light adjustment button simultaneously for about 2 seconds again to switch back to the original mode

simultaneously for about 2 seconds

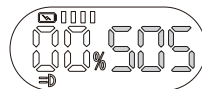
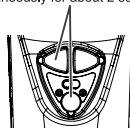

When in SOS mode

- This product is equipped with a memory function that remembers the mode and light intensity when the light was turned off and maintains the same setting the next time it is turned on. If different light intensities are set for wide and spot lights, the respective light intensity setting is remembered.
- Flash sensor mode can also be remembered and the mode and setting can be maintained for the next time it is turned on
- Blinking signal mode and SOS mode are automatically canceled when turned off

# Replacing the light head

This product is compatible with separately sold light heads that have different maximum luminous power.

Program switch is required following the procedure below after replacing the light head.



## Procedure to switch the program

- 1 Hold down the power/light adjustment button for about 7 seconds while turned off

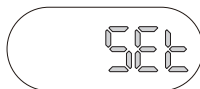
- Do not operate towards the face as the light may turn on.
- After [SET] flashes several times, the program number of the light head before replacing flashes on the LCD panel.



- 2 Select the program number of the light head after replacing using the light intensity adjustment buttons (+)(-)
- 3 Fix the program switch by pressing the power/light adjustment button

Program number	LCD panel display	Corresponding light head
40F		LX-4000SW FS
24F		LX-2400SW FS
12F		LX-1200SW FS

# Safety design

## High temperature protection mode

If the light head reaches over 55°C (131°F), it automatically moves to protection mode and decreases the light intensity to 20%. The [HOT] warning is displayed on the LCD panel. If high temperature protection mode is engaged, we recommend turning off the power and cooling down the light head. Use caution when handling such as not touching the light head with bare hands, as the light head may get extremely hot. When the temperature drops below 45°C (113°F), it returns to normal mode.

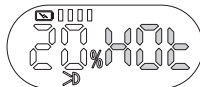

## Safety mode

When the remaining battery becomes low, the light intensity automatically drops to 20% and the battery indicator begins to blink. The display shows the remaining lighting time [10min] and starts counting down. Light intensity adjustment is not possible during safety mode.

### CAUTION

- After entering safety mode, start surfacing immediately for your safety.
- Please note the remaining lighting time displayed on the LCD panel may differ from the actual remaining lighting time due to the battery condition or circumstances such as surrounding water temperature.

## Care and storage precautions

### ⚠ CAUTION

- After use, soak the product in fresh water thoroughly as shown in the illustration under waterproof conditions and wash it under running water. Wash movable parts (levers, buttons etc.) moving them. Be careful not to loosen the light head when washing.
- If the product is not sufficiently soaked in fresh water or simply rinsed under running water, salt will remain and as it dries, the salt will crystallize and will not dissolve easily in water. Salt crystals adhering to the product are very difficult to remove and may cause flooding, therefore make sure to sufficiently soak the product in fresh water.
- After washing the product in water, thoroughly wipe dry with a soft cloth and dry in the shade.
- Do not use heat-generating equipment to force dry the product as it may cause deformation or damage.
- If you do not use the product for an extended period of time, store it away from high temperatures, high humidity, direct sunlight and extremely cold temperatures.
- After use, remove the battery from the product and store.
- After use, maintain the O-rings before storage. It is advisable to inspect the O-rings before and after use and replace them early.
- Although it depends on the frequency of use and storage conditions etc., we recommend that you have the product overhauled (for a fee) once every two years after purchase to maintain performance.
- If you do not use the product for an extended period of time, perform a test flash to keep internal electronic parts from deterioration by installing batteries once a month.

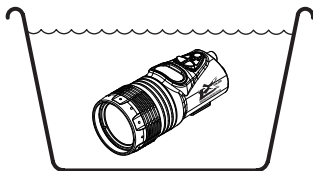

# Specifications

Luminous power	wide: 2400lm / spot: 1500lm
Beam angle (underwater)	wide: 100° / spot: 30°
Color temperature	wide: 5500K / spot: 6500K
Color rendering index	wide: RA90 / spot: RA70
Continuous burn time	wide: 60mins / spot: 90mins
Power adjustment	4-step light adjustment (25% increments) 100-step light adjustment (1% increments)
Flash sensor	⊙
Remote control	⊙
Interface	Color LCD panel
Power	Rechargeable Li-ion battery 3400mAh/7.4V
Charge time	2.5h
Battery charging method	1: Direct charging method / 2: Removable Charging method
Size	Φ58×139mm (projections excluded)
Weight (battery included)	430g (in air) / 163g (underwater)
Accessory mount	M52

**SEA&SEA**